

V1-3 SUNS

UNBOXING & MOUNTING INSTRUCTIONS



Supported Models

Aureole Collection | V_{1/3}

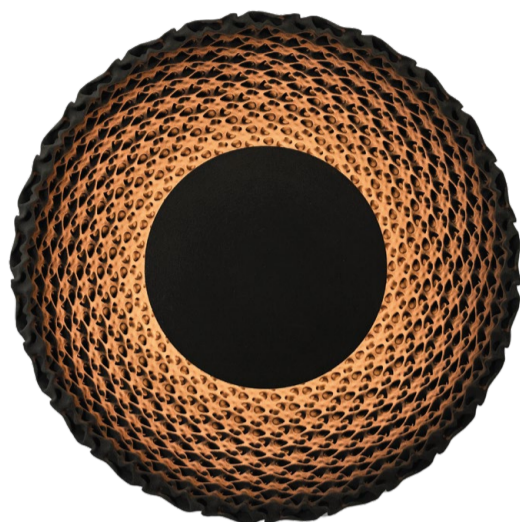

SUN V.01



SUN V.02

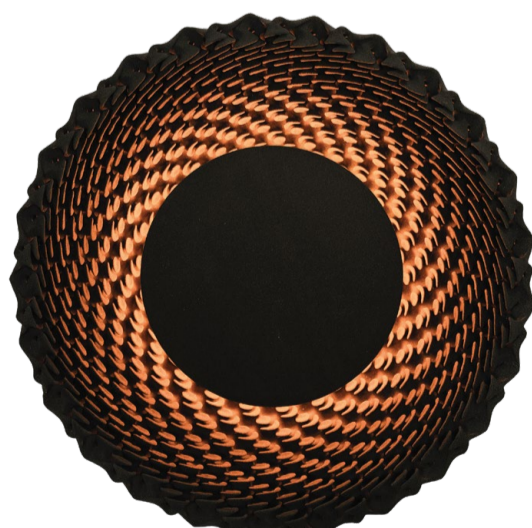

SUN V.03



Assembly

Exploded View





Parts List

Individual Components

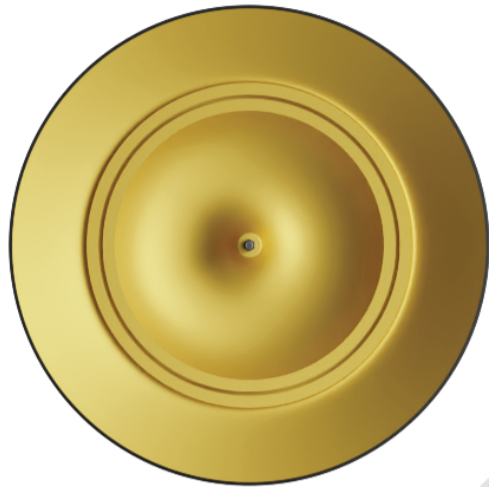

IRIS Reflector



E27 Bulbs



Sand Shade



Light Block



Mount Bolts



Wall Fixture



Screws & Washers



Wall Plugs

01

UNPACKING

Separating Components

- *Exercise caution when removing items from the wooden crate and unwrapping the black plastic packaging.*
- *Ensure all components are removed from the crate to avoid overlooking any essential parts.*
- *Place the unpacked components on a soft surface, such as foam, to prevent scratches or damage during assembly.*



02

DISMANTLE

Separating Components

To prepare for installation, it's necessary to separate some components. This process ensures a smooth and straightforward installation experience. Follow the steps below to safely disassemble your lamp.



Unscrew the three E27 Bulbs

01.

02.

Remove the Light Block component



Unscrew the 3 outer Mount Nuts with the provided Allen key

03.

04.

THIS STEP MIGHT REQUIRE TWO PEOPLE

*With both hands positioned under the Sand Shade,
lift vertically to separate it from the Wall Fixture.
Place the piece aside on a soft surface, such as foam,
to prevent damage*



03

MOUNTING

Attaching Bracket Fixture



Once you've chosen the mounting location, use the provided **Hole Stencil** to accurately mark the drilling points. Ensure that the wires for connection are positioned centrally.

01

02

If utilizing the provided **Cement Plugs**, drill holes measuring 8mm in diameter. Insert the plugs securely into each hole.

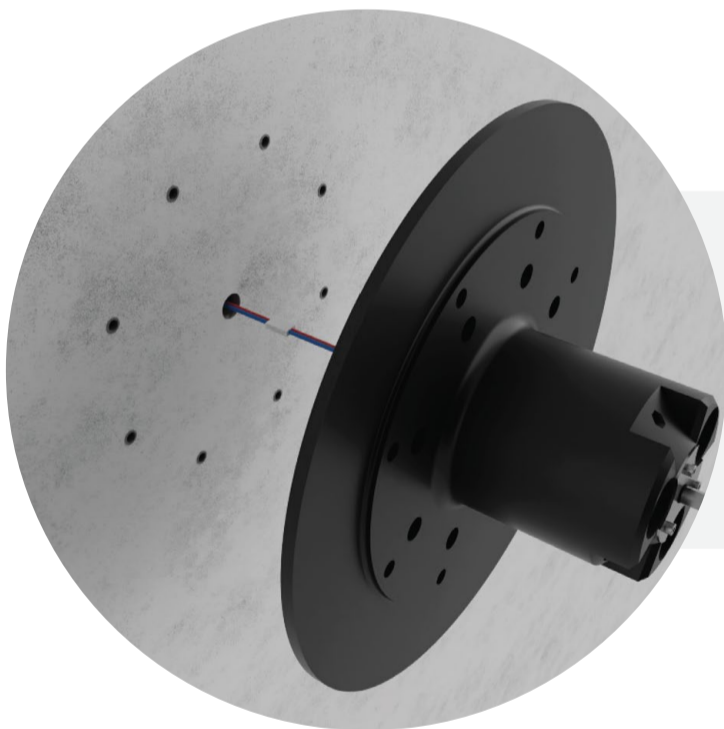
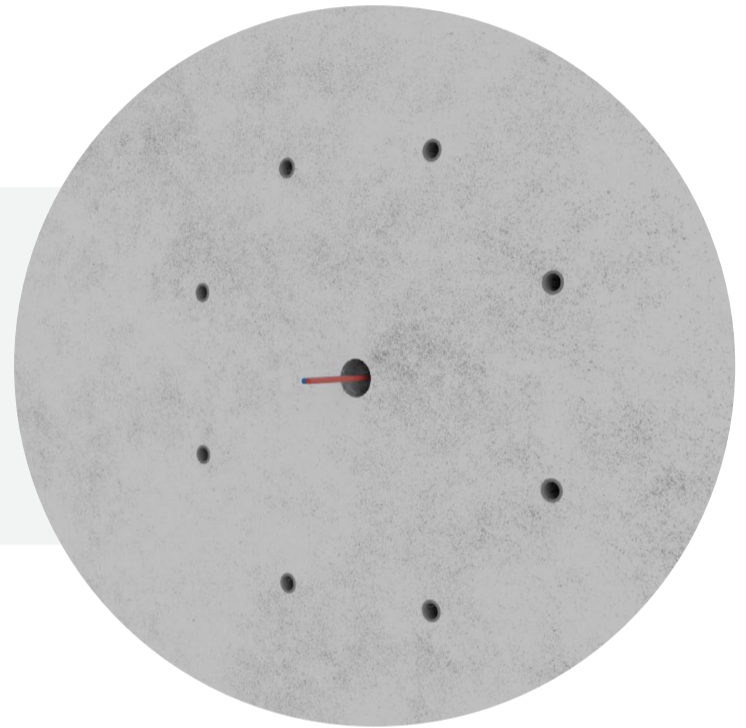

Connect the live wire and neutral wire to the corresponding terminals on the power supply.

03

04

Screw the **Wall Fixture** securely to the wall, ensuring to place washers between the screw head and Wall Fixture.





While holding the Sand Shade from the inside and the back side, align the teeth on the Wall Fixture with the Sand Shade and slide into place.

05

IMPORTANT NOTE

The fixture will only fit in one orientation. One of the teeth and corresponding slots on the Wall Fixture is smaller - Find this one and line it up accordingly.

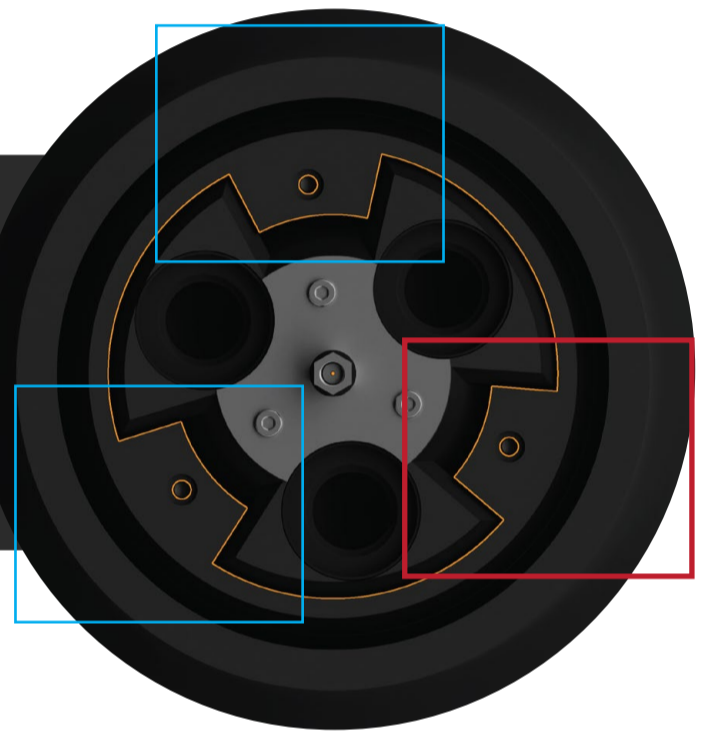

04

ASSEMBLE

Attach Final Components



Screw the three Mount Nuts into the holes. **01**

02

Place the Light Block back into position

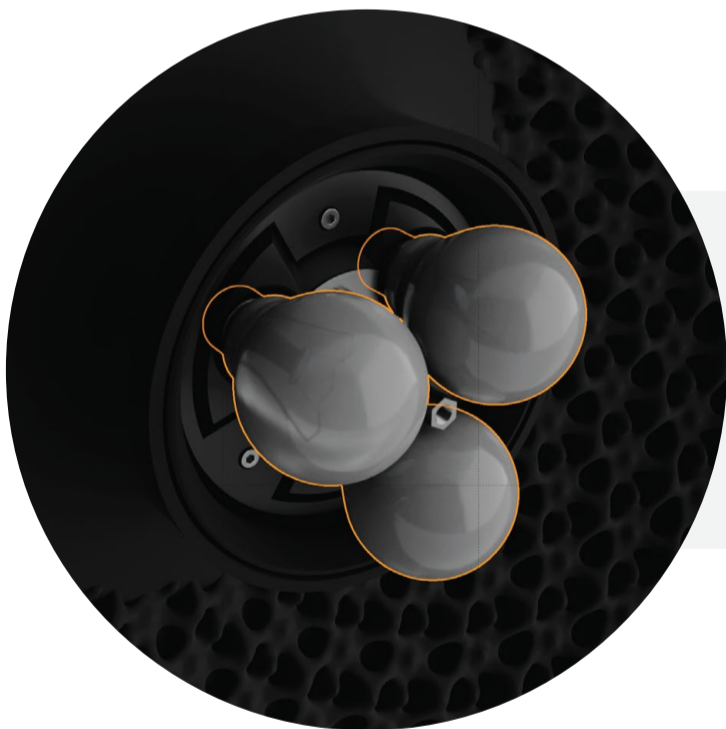

Screw the three E27 Bulbs into the fixture sockets **03**

04

Screw the IRIS into the central pin thread.
Make sure to always keep one hand on the IRIS until
it is securely threaded.

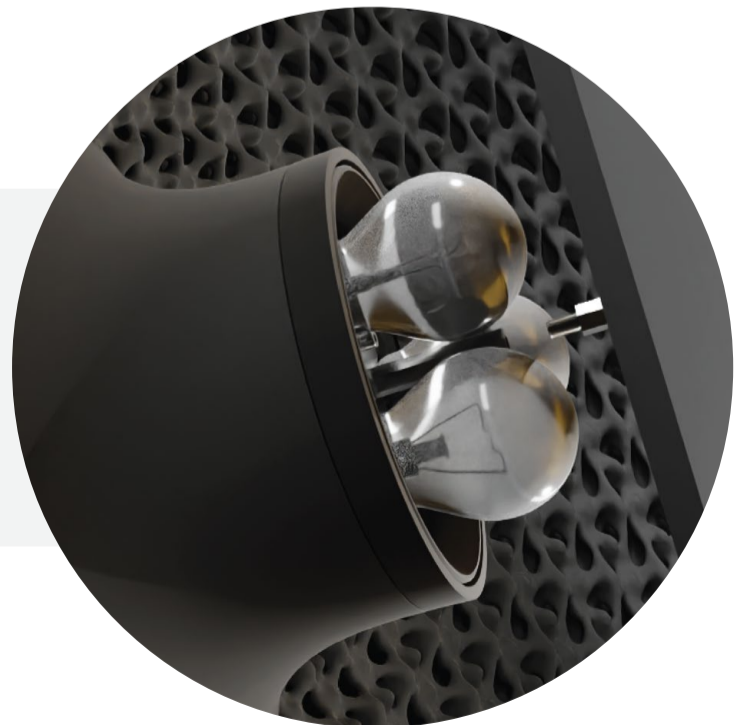

VOILÀ
Power It Up



ROLLO STUDIO

+31 621485253

info@rollostudio.com

ROLLO STUDIO